



CBP80 | BATH Ventilation

Cyclone[®]
Breathe Better

Ventilation Fan

Quickly remove odours and humidity with our very quiet, ENERGY STAR certified high-performance bath fan. Equipped with a high-density polyethylene (hard rigid plastic) fan for quiet operation and long-lasting durability, our ceiling-mounted fan meets all cETLus safety standards.

Customize with the following SMART Options:

-  **Humidity Sensor** to automatically regulate moisture and protect your home and family from mold
-  **LED Light Panel** for extra illumination without having to take up further ceiling space
-  **Bluetooth Speaker** connect to your various smart devices and enjoy audio entertainment from your Cyclone Bath Fan

Features

- 80 CFM
- 0.3 sones
- Thermal fuse protection
- ENERGY STAR certified
- Includes 4" duct connector
- Recommended for bathrooms up to 75 sqft (8' ceiling)

Housing

- Wiring from inside or outside housing with 8" leads
- 26 gauge galvanized steel housing (corrosion resistant)

Motor

- Includes a built in overload disconnect for safety and longer motor life
- Includes a capacitor start motor that performs with high efficiency and long lasting reliability
- Plug-in permanently lubricated motor



Installation

- Fit any joist from Min: 12" to Max: 24" width spans
- Can be mounted with flange or hanger bars
- 4" diameter duct connectors supplied
- Heavy duty triple point mounting brackets that can be adjusted up to 24 inch joist centers without vibration
- Premium grille is made of rugged polymeric resin for durability & comes with torsion spring clips for even mounting



Cyclone Range Hoods Inc.

1361 Huntingwood Drive, Unit 16. Toronto, ON. M1S 3J1. Canada.

Toll Free: 1-888-293-5662

Tel: (416) 293-0933

Fax: (416) 293-4793

Website: www.CycloneRangeHoods.com

CBP80 | BATH Ventilation

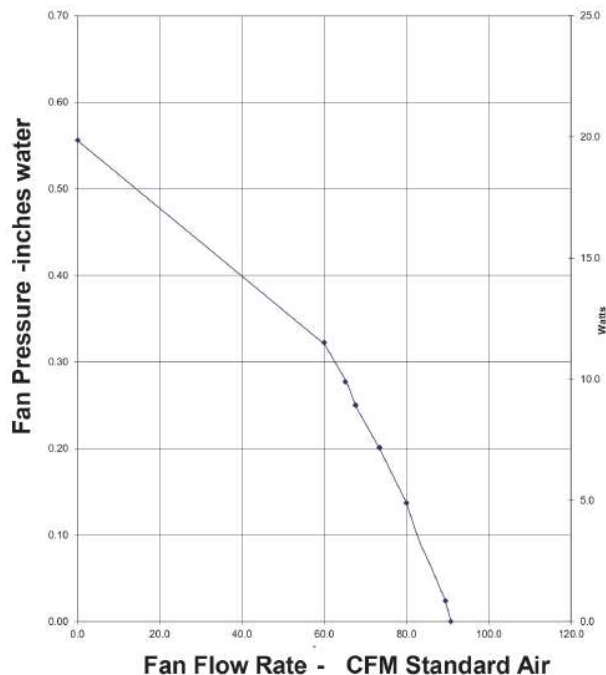

SPECIFICATIONS	CBP80
Static Pressure	0.1
Noise Level (Sones)	0.3
Air Flow Volume (CFM)	80
Current (Amps)	0.15
Power Consumption (Watts)	18
Electrical Connection (V/Hz)	120/60
Thermal Fuse Protection	Yes
Motor Type	AC
Blower Wheel	Centrifugal
Duct Diameter	4"
Humidity Sensor	*
LED Light Panel	*
Bluetooth Speaker	*

*Available Smart Options

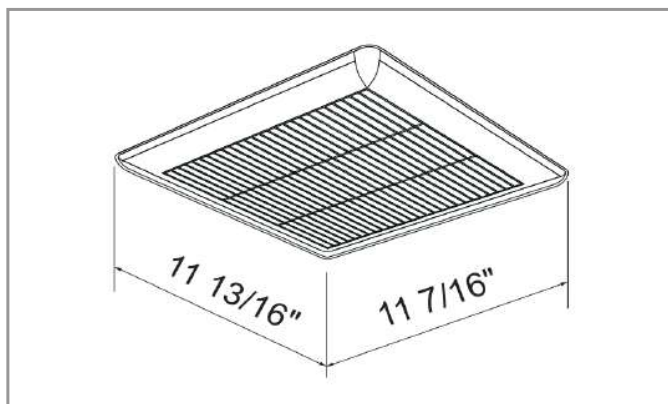
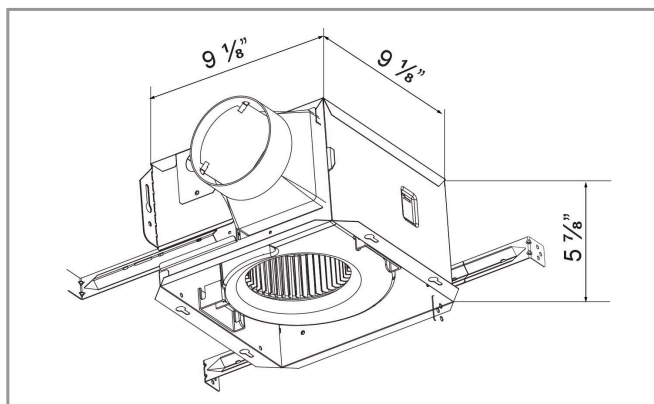

Model	Description	Packaging	Contractor Pack	Master Pack
CBP80	Bathroom Ventilation	Individual	-	Pack of 6
CBP80 MBG	80 CFM Motor/Blade/Grille	-	Pack of 8	-
PCB58 HSG	Housing for Model CBP50/CBP80/CBP100	-	Pack of 8	-
CBP80H	with Humidity Sensor	Individual	-	-
CBP80LED3	with LED Light panel	Individual	-	-
CBP80HLED3	with Humidity Sensor and LED Light Panel	Individual	-	-
CBP80BT	with Bluetooth Speaker	Individual	-	-
CBP80BTLED3	with Bluetooth Speaker and LED Light Panel	Individual	-	-